

## MOUNTING OPTIONS/MONTEGEOPTION

### HELMET BRACKET / HELMHALTERUNG

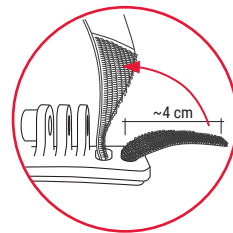

With **one velcro strap** / mit einem Klettband

Optimal mounting option for helmets with parallel ventilation slots. / Optimale Montagemöglichkeit für Helme mit parallel angeordneten Lüftungsöffnungen.

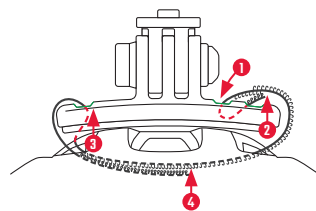

With **two velcro straps** / mit zwei Klettbändern

Alternative mounting option for helmets with ventilation slots shown on the right. / Alternative Montagemöglichkeit für Helme mit rechts dargestellten Lüftungsöffnungen.

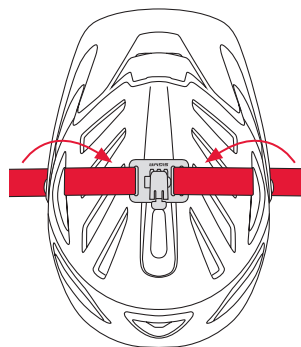
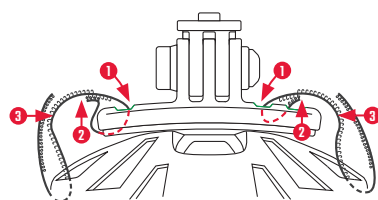

## FCC DECLARATION OF CONFORMITY



This device complies with Part 15 of the FCC Rules. Operation is subject to the following two conditions: (1) This device may not cause harmful interference, and (2) This device must accept any interference received, including interference that may cause undesired operation. The grantee is not responsible for any changes or modifications not expressly approved by the party responsible for compliance. Such modifications could void the user's authority to operate the equipment. This equipment should be installed and operated with a minimum distance of 5 millimeters between the radiator and your body.

### NOTE:

This equipment has been tested and found to comply with the limits for a Class B digital device, pursuant to part 15 of the FCC Rules. These limits are designed to provide reasonable protection against harmful interference in a residential installation. This equipment generates, uses and can radiate radio frequency energy and, if not installed and used in accordance with the instructions, may cause harmful interference to radio communications. However, there is no guarantee that interference will not occur in a particular installation. If this equipment does cause harmful interference to radio or television reception, which can be determined by turning the equipment off and on, the user is encouraged to try to correct the interference by one or more of the following measures:

- Reorient or relocate the receiving antenna.
- Increase the separation between the equipment and receiver.
- Connect the equipment into an outlet on a circuit different from that to which the receiver is connected.
- Consult the dealer or an experienced radio/TV technician for help.

### FCC Caution:

Any changes or modifications not expressly approved by the party responsible for compliance could void the user's authority to operate this equipment.

### Radiation Exposure Statement:

The product complies with the FCC portable RF exposure limit set forth for an uncontrolled environment and are safe for intended operation as described in this manual. The further RF exposure reduction can be achieved if the product can be kept as far as possible from the user body or set the device to lower output power if such function is available.



# BUSTER 1100 FRONTLIGHT HEADLIGHT

≤ 165m  
\* BUSTER 1100 HL

≤ 50h

USB-C  
FAST CHARGING

SAFE

## CE INFORMATION

**EN** SIGMA-ELEKTRO GmbH hereby declares that the BUSTER 1100/HL comply with the fundamental requirements and other relevant regulations of Directive 2014/30/EU and RoHS Directive 2011/65/EU. You can find the CE declaration at: [ce.sigma.bike/buster1100](http://ce.sigma.bike/buster1100), [ce.sigma.bike/buster1100hl](http://ce.sigma.bike/buster1100hl)

**DE** Hiermit erklärt SIGMA-ELEKTRO GmbH, dass sich die BUSTER 1100/HL in Übereinstimmung mit den grundlegenden Anforderungen und den anderen relevanten Vorschriften der Richtlinie 2014/30/EU und RoHS Directive 2011/65/EU befinden. Sie finden die Konformitäts-Erklärung unter folgendem Link: [ce.sigma.bike/buster1100](http://ce.sigma.bike/buster1100), [ce.sigma.bike/buster1100hl](http://ce.sigma.bike/buster1100hl)

**FR** Vous trouverez la déclaration CE à l'adresse : [ce.sigma.bike/buster1100](http://ce.sigma.bike/buster1100), [ce.sigma.bike/buster1100hl](http://ce.sigma.bike/buster1100hl)

**IT** La dichiarazione CE è disponibile all'indirizzo: [ce.sigma.bike/buster1100](http://ce.sigma.bike/buster1100), [ce.sigma.bike/buster1100hl](http://ce.sigma.bike/buster1100hl)

**ES** Puede encontrar la declaración de conformidad CE en: [ce.sigma.bike/buster1100](http://ce.sigma.bike/buster1100), [ce.sigma.bike/buster1100hl](http://ce.sigma.bike/buster1100hl)

**NL** U kunt de CE-certificering vinden op: [ce.sigma.bike/buster1100](http://ce.sigma.bike/buster1100), [ce.sigma.bike/buster1100hl](http://ce.sigma.bike/buster1100hl)

## MOUNTING/MONTAGE

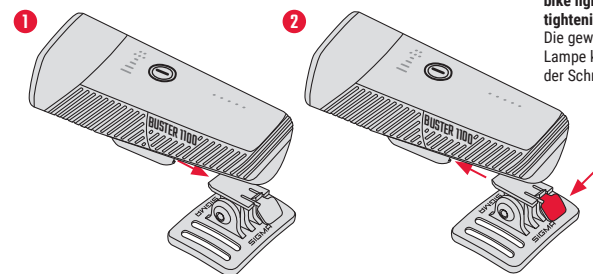

The desired position of the bike light can be locked by tightening the screw. / Die gewünschte Position der Lampe kann mit dem Anziehen der Schraube arretiert werden.

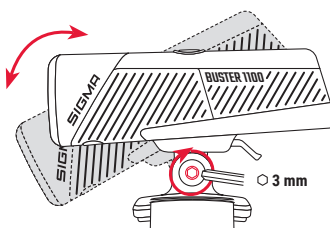

**SIGMA TIP:**  
Tighten the screw so that you can also adjust your bike light without tools while driving. /  
**SIGMA TIPP:**  
Drehen Sie die Schraube so fest, dass Sie Ihre Lampe während der Fahrt auch werkzeuglos einstellen können.

## VIDEO TUTORIALS



[gota.sigma.bike/busterhelmet/video](http://gota.sigma.bike/busterhelmet/video)

## UKCA STATEMENT



We, SIGMA-ELEKTRO GmbH, declare that the equipment above has been tested in our facility and found compliance with the requirement limits of applicable standards, in accordance with the Electromagnetic Compatibility Regulations 2016 and the Restriction of the Use of Certain Hazardous Substances in Electrical and Electronic Equipment Regulations 2012. The test record, data evaluation and Equipment Under Test (EUT) configurations represented herein are true and accurate under the standards herein specified.

## WARNING / WARNHINWEIS!

Possibly dangerous optical radiation! Never look directly into the lamp or point it at other people's eyes while it is in operation. It is essential to observe the further safety instructions in the enclosed sheet, especially regarding the lighting.



Möglicherweise gefährliche optische Strahlung! Schauen Sie bei Betrieb niemals direkt in die Lampe oder richten diese niemals auf die Augen von anderen Personen. Weitere Sicherheitshinweise im beiliegenden Blatt unbedingt beachten, insbesondere zur sicheren Verwendung der Beleuchtung.

## DO YOU ALSO KNOW OUR BIKE COMPUTERS?

More SIGMA Bike Computers at [sigma.bike](http://sigma.bike)



ROX 4.0 GPS ROX 12.1 EVO GPS

## ACCESSORIES / ZUBEHÖR

Please visit [sigma.bike](http://sigma.bike) for available accessories / Besuche [www.sigma.bike](http://www.sigma.bike) für verfügbares Zubehör



<https://cutt.ly/NwG0DT1f>

**SIGMA-ELEKTRO GmbH**  
Dr. - Julius - Leber - Straße 15  
67433 Neustadt / Wstr.  
Germany  
[service@sigma.bike](mailto:service@sigma.bike)



Designed in Germany  
Manufactured in China

189870/3

## MOUNTING/ MONTAGE

### SCREW-BRACKET MOUNT / SCHRAUBHALTERUNG

Adjust the BUSTER 1100 so that it does not blind other road users. The BUSTER 1100 must be securely attached to the bike and light distribution must not be obstructed. / Stellen Sie die BUSTER 1100 so ein, dass andere Verkehrsteilnehmer nicht geblendet werden. Die BUSTER 1100 muss fest mit dem Rad verbunden sein und die Lichtverteilung darf nicht verdeckt sein.

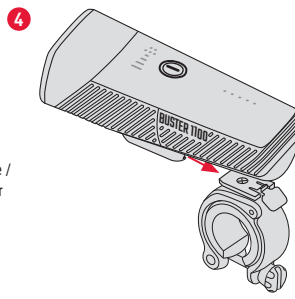
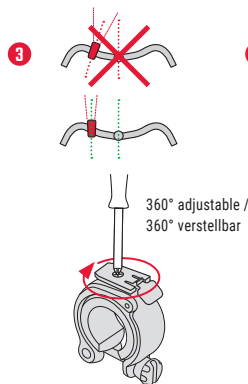
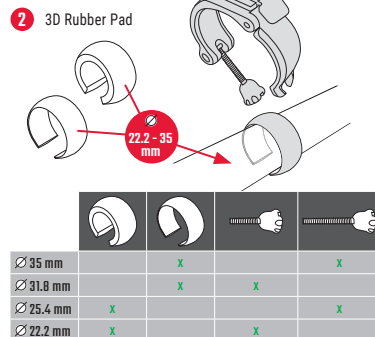
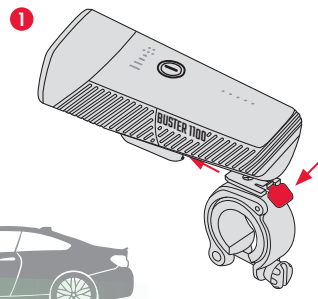

## 3D RUBBER PAD ADJUSTMENT / JUSTIERUNG

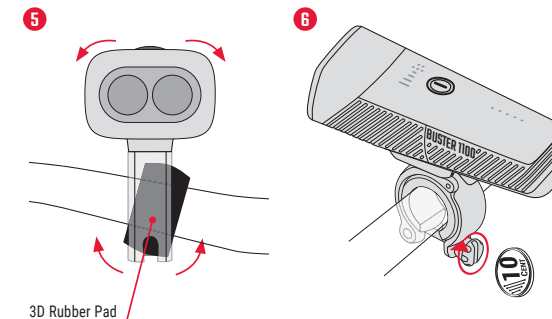

## ADAPTER FOR ACTION CAMERA BRACKET / ADAPTER FÜR ACTION CAMERA HALTERUNG

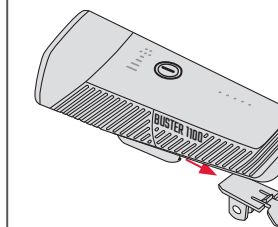

## VIDEO TUTORIALS

Detailed tutorials and application tips can be found at this link.

Detaillierte Tutorials und Anwendungstipps finden Sie unter diesem Link.

[goto.sigma.bike/buster1100/service](https://goto.sigma.bike/buster1100/service)



## 6 MODES / 6 MODI

BUTTON	MODE	INDICATOR	LUMENS	RUN TIME
2 x short click	ON / Last Mode			
+ 1 x click	HIGH		≤ 1100	≤ 2 h
+ 1 x click	MID		≤ 800	≤ 2,5 h
+ 1 x click	LOW		≤ 400	≤ 5 h
+ 1 x click	ECO		≤ 150	≤ 16 h
+ 1 x click	NIGHT FLASHING		≤ 800/400	≤ 5 h
+ 1 x click	DAY FLASHING		≤ 200	≤ 50 h
+ 1 x click				

1 x long click 2 sec. → OFF

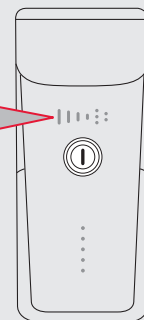

**THERMAL PROTECTION CIRCUIT:**  
The lamp is sufficiently cooled while riding. If the temperature of the lamp rises above 60 °C, it automatically switches to the next weaker mode.

**THERMISCHE SCHUTZSCHALTUNG:**  
Während der Fahrt wird die Lampe ausreichend gekühlt. Sollte die Temperatur der Lampe über 60 °C steigen so wechselt diese automatisch in den nächst schwächeren Modus.

## PRESET MODE PROFILES / VOREINGESTELLTE MODI-PROFILE

### PROFILE SELECTION:

You can adapt your BUSTER 1100 individually to your requirements. For this purpose, the lamp has 5 different profiles that you can select as follows. Hold down the ON/OFF button for longer than 5 seconds when it is switched off, then you will get to the profile selection. The lamp flashes once for profile 1, twice for profile 2 and so on. To select the desired profile, press the ON/OFF button once. Your selection is confirmed by four short flashes of the front LED. To RESET the PROFILE, proceed as for the PROFILE 1 setting: flash once. RESET corresponds to PROFILE 1.

### PROFILAUSSWAHL:

Sie können Ihre BUSTER 1100 auf Ihre Anforderungen individuell anpassen. Hierzu verfügt die Lampe über 5 verschiedene Profile die Sie wie folgt auswählen können. Halten Sie den ON/OFF Button im ausgeschalteten Zustand länger als 5 sec. gedrückt, dann gelangen Sie in die Profilauswahl. Die Lampe blinkt 1 mal für Profil 1, 2 mal für Profil 2 und so weiter. Um das gewünschte Profil auszuwählen den ON/OFF Button 1x drücken. Ihre Auswahl wird durch viermaliges, kurzes Aufleuchten der Front-LED bestätigt. Für einen RESET der PROFILE gehen Sie wie bei Einstellung PROFIL 1 vor: 1x blinken. RESET entspricht PROFIL 1.

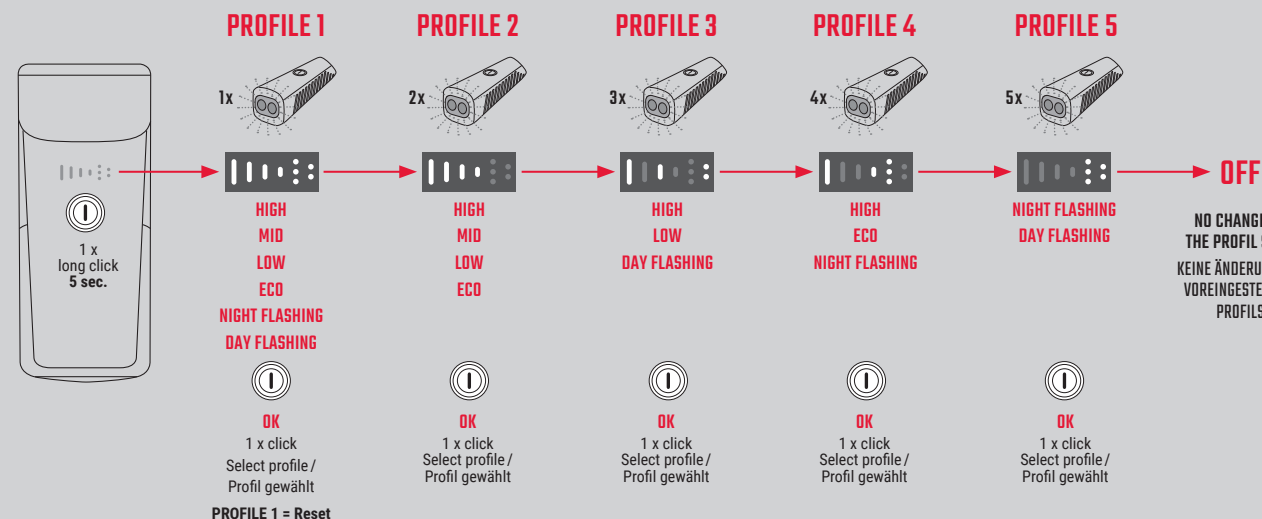

## MODE MEMORY FUNCTION / MODE MEMORY FUNKTION

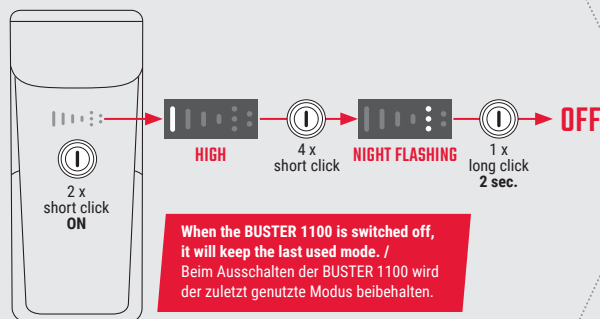

## EXAMPLE / BEISPIEL

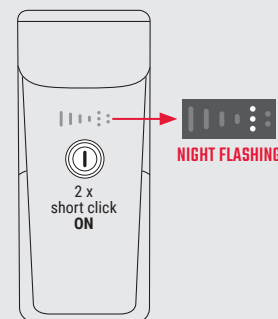

## BATTERY INDICATOR / AKKUINDIKATOR

### BATTERY STATUS / AKKU-STATUS

In the switched-off state, 1x short click shows the current battery status. / Im ausgeschalteten Zustand 1x kurzer Klick zeigt den aktuellen Akku-Status an.

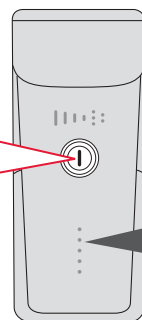

**NOTE:** If the battery capacity is less than 20 %, the red indicator LED lights up and after about 45 minutes, the red LED begins flashing, and the BUSTER 1100 goes out completely shortly thereafter. / **HINWEIS:** Bei weniger als 20 % Akku-Kapazität leuchtet die rote Indikator-LED auf und nach etwa 45 Min. blinkt die rote LED. In Kürze geht die BUSTER 1100 komplett aus.

100 - 82 %	81 - 63 %	62 - 44 %	43 - 25 %	24 - 20 %	19 - 5 %	<5 %
------------	-----------	-----------	-----------	-----------	----------	------

## CHARGING / LADEVORGANG

Charge the lamp only at room temperature. Charging is not possible outside the charging temperature range of +10 °C to +45 °C (50 °F to 110 °F) (recognisable by the rapid flashing of the red indicator LED). / Laden Sie die Lampe nur bei Raumtemperatur auf. Aufladen ist nicht möglich (erkennbar am schnellen Aufblinker der roten Indikator-LED).

Ensure that the USB sealing marked red is always closed correctly after charging. / Achten Sie bitte darauf, dass die rot markierte Abdichtung nach dem Ladevorgang stets korrekt verschlossen ist.

No energy can be transferred out through the USB-C connection. / Eine Energieentnahme über den USB-C-Anschluss ist nicht möglich.

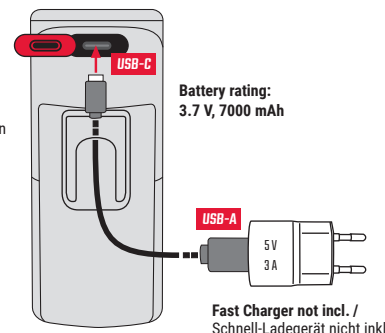

## CHARGING INDICATOR / LADEINDIKATOR



Charging approx. 3 h at 5V 3 A / Ladevorgang ca. 3 h bei 5V 3 A

0 - 24 %	25 - 43 %	44 - 62 %	63 - 81 %	82 - 90 %	>90 %
----------	-----------	-----------	-----------	-----------	-------

## TECHNICAL DATA / TECHNISCHE DATEN

Charging Temperature: +10 °C to +45 °C / 50 °F and 110 °F  
Battery Type: 3.7 V, 7000 mAh  
Max power: 3 W  
Water and Dust rating: IP44